

# BOLSAS DE TELA

## NUEVAS CALIDADES DE ALGODÓN

Alta Calidad 140 gr.  
Superior 180-220 gr.  
Premium 340 gr.

## ALGODÓN ORGANICO

Algodón certificado GOTS

## MATERIALES RECICLADOS

Nuevas bolsas de algodón 100% reciclado. Plástico reciclado PET.

FABRICA TU BOLSA A MEDIDA

## COMERCIO JUSTO

Algodón certificado etiqueta Fair-Trade

## OTROS MATERIALES

Tejido No Tejido, TNT Laminado y Rafia





# **BOLSAS DE TELA PERSONALIZADAS AL POR MAYOR**

WHOLESALE CUSTOM TOTE BAGS

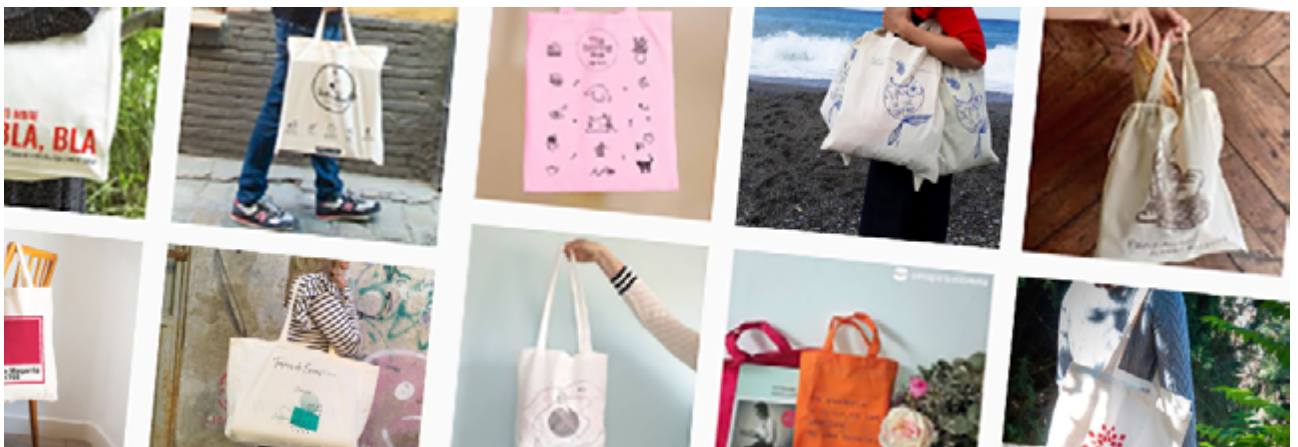

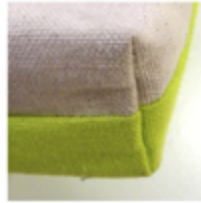

**LAS BOLSAS REUTILIZABLES SON LA OPCIÓN IDÓNEA A LA HORA DE COMBINAR PUBLICIDAD Y RESPETO POR EL MEDIO AMBIENTE; CUIDAMOS EL RESULTADO FINAL PARA QUE TU MENSAJE ADQUIERA VISIBILIDAD Y PERMANENCIA EN EL TIEMPO.**

**REUSABLE BAGS ARE THE IDEAL CHOICE WHEN COMBINING ADVERTISING AND ENVIRONMENTAL AWARENESS. WE CARE ABOUT THE STRENGTH AND DURABILITY OF BAGS AND MARKING. TOTE BAGS ARE THE PERFECT SURFACE FOR YOUR MESSAGE TO ACQUIRE MOBILITY AND PERMANENCE.**

### ¿QUÉ NOS HACE DIFERENTES?

- Nuestra especialización en **bolsas de tela al por mayor** garantiza la calidad de los materiales y los procesos de fabricación.
- **Personaliza tu bolsa** escogiendo entre una gran variedad de colores, hasta 28 en stock en las **bolsas de algodón** y 18 en las **bolsas de tejido no tejido**.
- Utilizamos tintas 100% ecológicas y máquinas de marcaje automático.
- Hasta 300.000 unidades en stock para **venta al por mayor** de los productos más vendidos.
- Alto gramaje, refuerzo en las asas y costuras rematadas en el interior de las bolsas de algodón y refuerzo en cruz en las asas de no-tejido.
- Promovemos la conciencia social en cuestiones medio ambientales, así como **la fabricación nacional**. Nuestro modelo de negocio está basado en la Responsabilidad Social Corporativa-RSC.
- Nuestros clientes son la base de nuestra empresa.

### WHAT MAKE US DIFFERENT?

- *Our specialization in tote bags ensures the quality of materials and the manufacturing process.*
- *We use 100% organic inks and automatic labeling machines.*
- *Up to 300,000 units in stock of the top selling products.*
- *Higher quality in workmanship, finishing, weight resistance.*
- *We support social consciousness in Environmental issues and national manufacture.*
- *Our customers are the foundation of our company.*



## CONFECCIÓN Y ACABADO

Las **bolsas, sacos o mochilas de algodón** de nuestro stock tienen el interior y las asas reforzadas con costuras rematadas, compuestos con un gramaje mínimo de 140 gr/m2, garantizando así una gran resistencia y firmeza como soporte para serigrafías, a la vez que mejora la opacidad y textura de la bolsa.

*Our cotton stock products are reinforced in the interior and handles with strong stitchery. With a weight of 150 gr/m2 supplies resistance and firmness to printing also giving an improvement opacity and texture to the bag.*

## PREIMPRESIÓN

Si los contrastes entre la tela y la tinta de la serigrafía son muy fuertes, se trabaja con una base de imprimación blanca sobre la tela, ayudando esto a resaltar y conseguir colores más puros y limpios, cubriendo los poros del tejido.

*If there is a high contrast between the tissue and the ink, we usually work with a white underbase over the tissue. This way we obtain better results with purer and cleaner colours.*

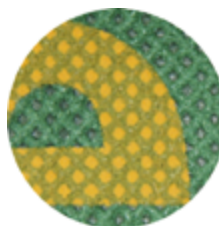

SIN BASE BLANCA

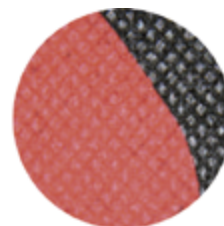

CON BASE BLANCA

## CUATRICROMÍA

La cuatricromía es un proceso de estampación que se realiza mediante puntos de impresión, consiguiendo una gama cromática muy amplia. El resultado es muy fiel a una fotografía, pero hay que tener en cuenta que sobre tejido el resultado nunca será igual al de una impresión sobre papel.

*The four colour process CMYK is a printing process made by points of impression obtaining an ample spectrum of colours. the result isn't similar to a photography but its quality is very faithful. Know that the production over tissue will never be like print over paper.*



ARCHIVO DIGITAL



IMPRESIÓN SOBRE BOLSA DE ALGODÓN NATURAL

## IMPRESIÓN DIGITAL

La impresión digital consiste en realizar una técnica de personalización textil directa sobre las prendas con mecanismos de gran calidad y materiales de última generación. Los diseños sobre las bolsas quedan con una calidad única.

*The digital impression consists of creating a technique of direct textil personalization on the items with great quality of latest mechanism and materials with which the design remains on the products with an unique quality.*



ARCHIVO DIGITAL



IMPRESIÓN SOBRE BOLSA DE ALGODÓN NATURAL



Más de 300.000 bolsas en stock de los modelos más vendidos  
More than 300.000 bags in stock of our best-selling models

## PRODUCTOS PRODUCTS



### ALGODÓN DE ALTA CALIDAD HIGH QUALITY COTTON

- 05 Bolsas / Bags
- 10 Mochilas / Rucksacks
- 12 Sacos / Sacks



### ALGODÓN SUPERIOR SUPERIOR COTTON

- 13 Bolsas / Bags



### ALGODÓN PREMIUM LONETA PREMIUM COTTON

- 15 Bolsas / Bags



### ALGODÓN ORGÁNICO ORGANIC COTTON

- 18 Bolsas / Bags
- 19 Mochilas / Rucksacks
- 19 Sacos / Sacks



### ALGODÓN COMERCIO JUSTO FAIRTRADE COTTON

- 20 Bolsas / Bags
- 22 Mochilas / Rucksacks
- 23 Sacos / Sacks



### MATERIALES RECICLADOS RECYCLED BAGS

- 24 Bolsas / Bags
- 25 Bolsas / Bags



### TEJIDO NO TEJIDO NON-WOVEN

- 26 Bolsas / Bags
- 29 Bolsas plegables / Foldable Bags
- 31 Sacos y Mochilas / Sacks & Rucksacks



### TNT LAMINADO Y RAFIA LAMINATED NON-WOVEN & RAFFIA

- 34 No-tejido laminado / Non-Woven laminated
- 35 Rafia / Raffia



### MASCARILLAS FACE MASKS

- 36 Mascarillas higiénicas reutilizables / Reusable face masks

### FABRICA TU BOLSA A MEDIDA MAKE YOUR OWN BAG

- 40 Fabrica tu propia bolsa a medida / Make your own custom bag
- 42 Fabricación Nacional / Made in Spain
- 43 Importación directa / Direct import
- 44 Información de Producto / Product Information
- 44 Instrucciones de Lavado / Care Instructions

**De importación o nacional.  
Te ofrecemos la posibilidad de  
fabricar la bolsa que necesitas  
a tu medida.**

Import or national production.  
We offer the possibility of  
manufacturing any bag you need.



#### Leyenda de Catálogo



Tamaño aprox.  
Size



Gramaje  
Weight



Unidades por caja  
Units per box



Área máxima de impresión  
Maximum print area



Asas  
Handles

## COLORES EN ALGODÓN COTTON COLOR

	<b>COLOR: NATURAL</b> CÓDIGO COLOR CATÁLOGO: N		<b>COLOR: SALMÓN</b> CÓDIGO COLOR CATÁLOGO: 23		<b>COLOR: AZUL CYAN</b> CÓDIGO COLOR CATÁLOGO: 47		<b>COLOR: MARRÓN</b> CÓDIGO COLOR CATÁLOGO: 77
	<b>COLOR: AMARILLO</b> CÓDIGO COLOR CATÁLOGO: 03		<b>COLOR: ROSA</b> CÓDIGO COLOR CATÁLOGO: 26		<b>COLOR: MENTA</b> CÓDIGO COLOR CATÁLOGO: 49		<b>COLOR: GRIS CLARO</b> CÓDIGO COLOR CATÁLOGO: 91
	<b>COLOR: AMARILLO HUEVO</b> CÓDIGO COLOR CATÁLOGO: 04		<b>COLOR: FUCSIA</b> CÓDIGO COLOR CATÁLOGO: 27		<b>COLOR: AZUL PETRÓLEO</b> CÓDIGO COLOR CATÁLOGO: 55		<b>COLOR: GRIS</b> CÓDIGO COLOR CATÁLOGO: 96
	<b>COLOR: MANDARINA</b> CÓDIGO COLOR CATÁLOGO: 07		<b>COLOR: LAVANDA</b> CÓDIGO COLOR CATÁLOGO: 30		<b>COLOR: VERDE BOSQUE</b> CÓDIGO COLOR CATÁLOGO: 56		<b>COLOR: GRAFITO</b> CÓDIGO COLOR CATÁLOGO: 97
	<b>COLOR: ROJO</b> CÓDIGO COLOR CATÁLOGO: 14		<b>COLOR: AZUL MARINO</b> CÓDIGO COLOR CATÁLOGO: 41		<b>COLOR: ESMERALDA</b> CÓDIGO COLOR CATÁLOGO: 63		<b>COLOR: GRIS PIZARRA</b> CÓDIGO COLOR CATÁLOGO: 98
	<b>COLOR: ROJO CEREZA</b> CÓDIGO COLOR CATÁLOGO: 15		<b>COLOR: AZUL ROYAL</b> CÓDIGO COLOR CATÁLOGO: 43		<b>COLOR: VERDE PRADO</b> CÓDIGO COLOR CATÁLOGO: 64		<b>COLOR: NEGRO</b> CÓDIGO COLOR CATÁLOGO: S
	<b>COLOR: BURDEOS</b> CÓDIGO COLOR CATÁLOGO: 18		<b>COLOR: AZUL CIELO</b> CÓDIGO COLOR CATÁLOGO: 45		<b>COLOR: VERDE CLARO</b> CÓDIGO COLOR CATÁLOGO: 67		<b>COLOR: BLANCO</b> CÓDIGO COLOR CATÁLOGO: W

## COLORES EN TEJIDO NO TEJIDO NON WOVEN COLOR

	<b>COLOR: BLANCO</b> CÓDIGO COLOR CATÁLOGO: W		<b>COLOR: ROJO</b> CÓDIGO COLOR CATÁLOGO: 23		<b>COLOR: AZUL CYAN</b> CÓDIGO COLOR CATÁLOGO: 47		<b>COLOR: VERDE OSCURO</b> CÓDIGO COLOR CATÁLOGO: 54
	<b>COLOR: ARENA</b> CÓDIGO COLOR CATÁLOGO: 73		<b>COLOR: MORADO</b> CÓDIGO COLOR CATÁLOGO: 37		<b>COLOR: VERDE AGUA</b> CÓDIGO COLOR CATÁLOGO: 53		<b>COLOR: ROSA</b> CÓDIGO COLOR CATÁLOGO: 21
	<b>COLOR: AMARILLO</b> CÓDIGO COLOR CATÁLOGO: 05		<b>COLOR: AZUL OSCURO</b> CÓDIGO COLOR CATÁLOGO: 41		<b>COLOR: VERDE LIMA</b> CÓDIGO COLOR CATÁLOGO: 69		<b>COLOR: GRIS</b> CÓDIGO COLOR CATÁLOGO: 91
	<b>COLOR: MANDARINA</b> CÓDIGO COLOR CATÁLOGO: 06		<b>COLOR: AZUL ROYAL</b> CÓDIGO COLOR CATÁLOGO: 43		<b>COLOR: VERDE CLARO</b> CÓDIGO COLOR CATÁLOGO: 67		<b>COLOR: AZUL PETRÓLEO</b> CÓDIGO COLOR CATÁLOGO: 55
	<b>COLOR: BURDEOS</b> CÓDIGO COLOR CATÁLOGO: 18						

\* La empresa no se responsabiliza de posibles alteraciones de color en la impresión del catálogo. Informamos que la bolsa pueden sufrir leves variaciones de color en función de la tintada de la misma. Our company is not responsible for possible color alterations in the catalogue impression. We inform that bags can suffer light color variations according to its own dyed.





# ALGODÓN DE ALTA CALIDAD HIGH QUALITY COTTON



Nuestro algodón de **Alta Calidad** tiene un gramaje de **140 gr/m<sup>2</sup>** reales, superior a otros productos de gramaje similar que se ofertan en el mercado. El algodón es una opción tan novedosa como tradicional a la hora de incorporar la sostenibilidad en nuestros hábitos diarios de consumo. Esta calidad asegura su larga durabilidad y resistencia gracias a los refuerzos de las asas y las terminaciones de las costuras. Todo esto, junto con las posibilidades de impresión, hacen de la bolsa de algodón un regalo promocional de alto valor ecológico y de gran utilidad para sus clientes potenciales.

*Our High Quality cotton has a grammage of real 140 gr/m<sup>2</sup> superior to other products of similar grammage that are offered in the market. Cotton is a very original but also traditional option, when mixing sustainability into our consumption daily habits. This quality offers a great durability and strength, due to the handles reinforcement and sewing finishing. All this together with high quality and printing possibilities, make the cotton bag a high ecological value promotional gift for your potential clients.*



**3842 L**

**Bolsa Tote Bag de algodón con dos asas largas**

Cotton Tote bag with two long handles

**TOP SELLER**

38x42cm

140gr/m<sup>2</sup>



max. print area  
28x28cm



**NOVEDAD**



**2040 K**

**Porta botellas de algodón con dos asas cortas**

Small cotton bag with two short handles



N W 97 S



**2226**

**Bolsa pequeña de algodón con dos asas cortas**

Small cotton bag with two short handles



W N 03 07 14 64



67 43 47 41 97 S



**2832**

**Bolsa mediana de algodón con dos asas cortas**

Medium cotton bag with two short handles



W N 03 07 14 64



67 43 47 41 97 S







**3842 K**

**Bolsa Tote Bag de algodón con dos asas cortas**

Cotton Tote bag with two short handles



140gr/m<sup>2</sup>



max. print area  
28x28cm



**3842 ZK**

**Bolsa de algodón con dos asas cortas y cordones**

Cotton bag with two short handles and two cords



140gr/m<sup>2</sup>



max. print area  
28x28cm



N



**3842 1 L**

**Bolsa de algodón con asa bandolera**  
Shoulder cotton tote bag



140gr/m<sup>2</sup>



max. print area  
28x28cm



N

S

W



**3842 K 1 L**

**Bolsa de algodón con asa bandolera y dos asas cortas**  
Shoulder cotton tote bag with short handles



140gr/m<sup>2</sup>



max. print area  
28x28cm



N



**3842 B**

**Bolsa de algodón con dos asas cortas y 5 cm de base**  
Cotton tote bag with two short handles and 5 cm bottom



140gr/m<sup>2</sup>



max. print area  
28x28cm

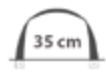

N

W

S





**384210 L**  
**Bolsa Tote Bag de algodón con fuelle y base de 10cm y dos asas largas**

Cotton bag with 10 cm bottom and two long handles

38x42+10cm

140gr/m<sup>2</sup>



max. print area  
28x28cm



**483612 L**  
**Bolsa de algodón con fuelle y base de 12 cm y dos asas largas**

Cotton bag with 12 cm bottom and long handles

48x36+12 cm

140gr/m<sup>2</sup>



max. print area  
30x25cm



**4540 T**  
**Bolsa de algodón con dos asas anchas**

Cotton bag with two broad handles

45x40 cm

140gr/m<sup>2</sup>



max. print area  
28x28cm



Ancho de asa/ Handle broadness: 4cm



N



**5050**

**Bolsa cuadrada de algodón con dos asas cortas**  
Square-shaped cotton bag with two short handles

50x50cm

140gr/m<sup>2</sup>



max. print area  
38x38cm



N



S



W



**7050**

**Bolsa grande de algodón con dos asas cortas**  
Big cotton bag with two short handles

70x50cm

140gr/m<sup>2</sup>



max. print area  
38x38cm

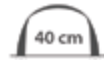

W



N



S



**2129 M**

**Mochila de algodón sin fondo con cordón doble**  
Cotton rucksack without bottom and double cords

21x29cm

140 gr/m<sup>2</sup>



max. print area  
12x15cm



N



W



S



67



03



07



14



27



41



43



97



**3846 M**

**Mochila de algodón sin fondo con cordón doble**

Cotton rucksack without bottom and double cords

38x46cm

140gr/m<sup>2</sup>



max. print area  
28x28cm



**Mochila de algodón con cordón simple y fondo redondo de 25 cm de diámetro**

Cotton rucksack with bottom and simple cords

40x54 cm

gr/m<sup>2</sup>



max. print area

**4054 R**

40x54 cm

140

200 u

25x25 cm

**4262 R**

42x62 cm

140

200 u

30x30 cm



N



**Mochila de algodón sin fondo con cordón simple**

Cotton rucksack without bottom and simple cords

25x35 cm

gr/m<sup>2</sup>



max. print area

**2535 M**

25x35 cm

140

500 u

15x25 cm

**4054 M**

40x54 cm

140

200 u

25x25 cm



N





## Sacos de algodón con cordón doble

Cotton sack with cords



gr/m<sup>2</sup>



max. print area

<b>1014 Z</b>	10x14 cm	140	1000 u	6x9 cm
<b>1520 Z</b>	15x20 cm	140	1000 u	8x13 cm
<b>2530 Z</b>	25x30 cm	140	500 u	18x18 cm
<b>3045 Z</b>	30x45 cm	140	250 u	24x30 cm



gr/m<sup>2</sup>



max. print area

<b>3842 Z</b>	38x42 cm	140	250 u	30x30 cm
---------------	----------	-----	-------	----------



N



gr/m<sup>2</sup>



max. print area

<b>4050 Z</b>	40x50 cm	140	250 u	30x30 cm
<b>5075 Z</b>	50x75 cm	140	200 u	38x38 cm





# ALGODÓN SUPERIOR SUPERIOR COTTON



Nuestro **Algodón Superior** tiene unos gramajes entre **180 gr/m<sup>2</sup>** y **220 gr/m<sup>2</sup>**, gramaje más grueso y de resistencia alta, perfecto para presentaciones de mejor calidad o que requiera gran durabilidad para el transporte de objetos. Al igual que todas nuestras bolsa, las de algodón superior tienen una larga durabilidad y resistencia gracias a los refuerzos de las asas y las terminaciones de las costuras. Todo esto, junto a las posibilidades de impresión, hacen de la bolsa de algodón un regalo promocional de alto valor ecológico y de gran utilidad para revender u ofrecer a clientes exclusivos.

Our **Superior Cotton** has grammages between **180 gr/m<sup>2</sup>** and **220 gr/m<sup>2</sup>**, thicker grammage and highly resistant, perfect for presentations of better quality or that require great durability for transporting objects. Like all our bags, the superior cotton ones have long-lasting durability and resistance thanks to the reinforcements on the handles and the seam finishes. All this, plus printing possibilities, make the cotton bag a promotional gift of high ecological value and very useful to resell or offer to exclusive clients.



**3842 L 180G N**

**Bolsa Tote Bag de algodón con dos asas largas**

Cotton Tote bag with two long handles

38x42cm

180gr/m<sup>2</sup>



max. print area  
28x28cm



N

180 gr



**384210 L 180G N**

**Tote Bag de algodón con base y fuelle de 10 cm y dos asas largas**

Cotton bag with 10 cm bottom and two long handles

38x42+10 cm

180gr/m<sup>2</sup>



max. print area  
28x28cm



N

180 gr



**3842 L 220G**

**Bolsa Tote Bag de algodón con dos asas largas**  
Cotton Tote bag with two long handles

38x42cm

220gr/m<sup>2</sup>



max. print area  
28x28cm

70 cm



N

S

41

43

220 gr



**384210 L 220G**

**Tote Bag de algodón con base y fuelle de 10 cm y dos asas largas**

Cotton bag with 10 cm bottom and two long handles

38x42+10cm

220gr/m<sup>2</sup>



max. print area  
28x28cm

70 cm



N

S

41

43

97

220 gr



**423810 L 220G N**

**Bolsa de algodón con base y fuelle de 10 cm y dos asas largas**

Cotton bag with 10 cm bottom and two long handles

42x38+10cm

220gr/m<sup>2</sup>



max. print area  
28x28cm

70 cm



N

220 gr





# ALGODÓN PREMIUM LONETA PREMIUM COTTON



Nuestro **Algodón Premium** tiene un gramaje de **340 gr/m<sup>2</sup>**. Son nuestras bolsas de mayor gramaje, también conocidas como de lona, loneta o "canvas". Gramaje muy resistente pensado para regalos de alta gama o de un gran peso. Son unas bolsas de gran durabilidad y vida larga. Y como todas nuestras bolsas, destacan por sus refuerzos de las asas y sus terminaciones en las costuras. Todo esto, junto las posibilidades de impresión, hacen de la bolsa de algodón un regalo promocional de alto valor ecológico y de gran utilidad para sus clientes potenciales.

*Our Premium Cotton has a grammage of 340 gr/m<sup>2</sup>. They are our heaviest weight bags, also known as canvas. Very resistant grammage designed for high-end or heavyweight gifts. They are bags of great durability and long life. And like all our bags, they stand out for their reinforced handles and their seam finishes. All this, together with the printing possibilities, make the cotton bag a promotional gift of high ecological value and very useful for your potential customers.*



**424210 L 340G**

**Bolsa de LONETA con base de 10 cm y dos asas largas**

Thick canvas bag with 10cm bottom and long handles

42x42+10cm

340gr/m<sup>2</sup>



max. print area  
28x28cm



N



340 gr



**424210 K 340G**

**Bolsa de LONETA con base de 10 cm y dos asas cortas**

Thick canvas bag with 10 cm bottom and two short handles

42x42+10cm

340gr/m<sup>2</sup>



max. print area  
28x28cm



N



340 gr



**483210 LK 340G**

**Bolsa de LONETA con fuelle y base de 10 cm, dos asas cortas y largas**

Canvas tote bag with bottom and 10 cm. bellows, two short and long handles

42x38+10cm

340gr/m<sup>2</sup>



max. print area  
28x28cm



N

**340 gr**



**384210 L 340G**

**Bolsa de LONETA con fuelle y base de 10 cm y dos asas largas**

Canvas tote bag with 10cm bottom and bellows, two long handles

38x42+10cm

340gr/m<sup>2</sup>



max. print area  
28x28cm



N

S

**340 gr**











# ALGODÓN ORGÁNICO ORGANIC COTTON



Nuestras bolsas de algodón orgánico cuentan con certificado **GOTS (Global Organic Textile Standard)**, el cual garantiza que todo el proceso de fabricación ha sido totalmente respetuoso con el medio ambiente; desde la misma recolecta del algodón hasta la propia confección de la bolsa.

**GOTS** fue desarrollado por organismos internacionales de normalización líderes a fin de definir requisitos con reconocimiento mundial que garanticen la condición orgánica de productos textiles, con el fin de ofrecer garantías creíbles a los consumidores.

El Global Organic Textile Standard ya ha ganado el reconocimiento universal apoyado por el crecimiento del consumo de fibras orgánicas y por la notable demanda de criterios de procesos unificados del sector industrial y minorista. **GOTS** permite a los procesadores y fabricantes suministrar sus productos textiles hechos con fibras orgánicas con una certificación aceptada en los mercados de venta más importantes.

*Our organic cotton tote bags feature **GOTS (Global Organic Textile Standard)** certificate. This certification ensures that all the manufacturing process has been totally respectful with the environment, from the cotton harvesting to the making of the tote bag itself.*

***GOTS** was developed by leading international standard setters in order to define world-wide recognised requirements that ensure organic status of textiles, in order to provide credible assurance to the consumer.*

*Supported by the growth in consumption of organic fibres and by the remarkable demand for unified processing criteria from the industry and retail sector, the Global Organic Textile Standard has already gained universal recognition. It enables processors and manufacturers to supply their textiles made from organic fibres with one certification accepted in all major selling markets.*



**3842 L OG**

**Bolsa de algodón ORGÁNICO con dos asas largas**  
Organic cotton bag with two long handles

38x42cm

140gr/m<sup>2</sup>



max. print area  
28x28cm





**3842 K OG**  
**Bolsa de algodón ORGÁNICO con dos asas cortas**  
 Organic cotton bag with two short handles



**3846 M OG**  
**Mochila de algodón ORGÁNICO sin fondo con cordón doble**  
 Organic cotton rucksack without bottom and double cords

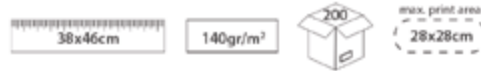

**Sacos de algodón ORGÁNICO con cordón doble**  
 Organic Cotton sack with double cords

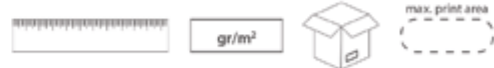

		gr/m <sup>2</sup>		max. print area
<b>1014 Z OG</b>	10x14 cm	140	1000 u	6x9 cm
<b>1520 Z OG</b>	15x20 cm	140	1000 u	8x13 cm
<b>2530 Z OG</b>	25x30 cm	140	500 u	19x20 cm



N



# COMERCIO JUSTO FAIR TRADE



El **comercio justo** es una forma alternativa de comercio promovido por varias organizaciones no gubernamentales, por la Organización de las Naciones Unidas y por los movimientos sociales y políticos como el pacifismo y el ecologismo que promueven una relación comercial voluntaria y justa entre productores y consumidores.

*The fair trade is an alternative way of commerce supported by many non-governmental organization, the United Nations and different social and politic movements such as pacifism and environmentalism in order to promote a voluntary and fair commercial relation between producers and consumers.*



## 3842 K FT

### Bolsa clásica de algodón con dos asas cortas

Cotton Tote bag with two short handles



## 3842 L FT

### Bolsa clásica de algodón con dos asas largas

Cotton tote bag with two long handles







**2226 FT**  
**Bolsa pequeña de algodón con dos asas cortas**  
Small cotton bag with two short handles

22x26cm

140gr/m<sup>2</sup>



max. print area  
14x16cm



N



**2832 FT**  
**Bolsa mediana de algodón con dos asas cortas**  
Medium cotton bag with two short handles

28x32cm

140gr/m<sup>2</sup>



max. print area  
17x20cm



N



**384210 L FT**  
**Bolsa de algodón con base y fuelle de 10 cm y dos asas largas**  
Cotton bag with 10 cm bottom and two long handles

38x42+10cm

140gr/m<sup>2</sup>



max. print area  
28x28cm



N



**483612 L FT**  
**Bolsa de algodón con base y fuelle de 12 cm**  
**y dos asas largas**  
 Cotton bag with 12 cm bottom and two long handles

48x36+12cm

140gr/m<sup>2</sup>



max. print area  
30x25cm



N



**3846 M FT**  
**Mochila de algodón sin fondo con cordón doble**  
 Cotton rucksack without bottom with double cords

38x46cm

140gr/m<sup>2</sup>



max. print area  
28x28cm



OEKO-TEX®  
STANDARD 100



### Saco de algodón con cordón y malla de PET

Cotton rucksack with double cords and PET mesh



gr/m<sup>2</sup>



max. print area

2530 Z F NET  
3040 Z F NET

25x30cm  
30x40cm

140  
140

500  
500

17x20cm  
22x30cm



N

OEKO-TEX®  
STANDARD 100



### Sacos de algodón sin fondo con cordón doble

Cotton rucksack without bottom with cords



gr/m<sup>2</sup>



max. print area

1014 Z FT  
1520 Z FT  
2530 Z FT  
3045 Z FT  
4050 Z FT

10x14cm  
15x20cm  
25x30cm  
30x45cm  
40x50cm

140  
140  
140  
140  
140

1000  
1000  
500  
250  
250

6x9cm  
8x13cm  
17x20cm  
22x30cm  
30x30cm



N



S



97



W

1560 Z FT

15x60 cm

140gr/m<sup>2</sup>



max. print area  
8x13cm



N

**NOVEDAD**





## MATERIALES RECICLADOS RECYCLED BAGS



El **PET** es un polímero plástico producido a partir de botellas de plástico recicladas. Esto hace de él la opción idónea si lo que buscas es combinar resistencia y acabado en un producto reciclado en su totalidad, que a su vez es 100% reciclable.

El **Algodón Reciclado** es un tejido que se obtiene del reciclado de otros productos hechos con algodón. Nuestras bolsas de algodón reciclado tienen un gramaje de **180 gr/m<sup>2</sup>** y acabados de calidad como todas nuestras bolsas.

***PET** is a plastic polymer made of recycled plastic bottles, which makes it a great option when combining resistance and end-result in a fully recycled and 100% recyclable product.*

***Recycled Cotton** is a fabric that is obtained from the recycling of other products made with cotton. Our recycled cotton bags have a weight of **180 gr/m<sup>2</sup>** and quality finishes like all our bags.*



**3842 L PT**

**Bolsa de PET reciclado con dos asas largas**

Recycled PET bag with two long handles

38x42cm

120gr/m<sup>2</sup>



max. print area  
28x28cm



W



**3842 K PT**

**Bolsa de PET reciclado con dos asas cortas**

Recycled PET bag with short handles

38x42cm

120gr/m<sup>2</sup>



max. print area  
28x28cm



W



**NOVEDAD**



**3842 L 180G RC**  
**Tote Bag de algodón reciclado con dos asas largas**  
Recycled cotton tote bag with long handles

38x42cm

180gr/m<sup>2</sup>



max. print area  
28x28cm



**GRIS  
MULTICOLOR**

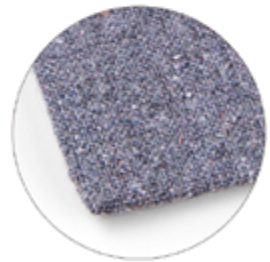



## TEJIDO NO TEJIDO NON WOVEN



El **Tejido No Tejido (TNT)** es un polipropileno respetuoso con el medio ambiente, ya que no utiliza agua en su proceso de producción y se desintegra si se ve expuesto de forma permanente al sol. Está fabricado a base de materiales libres de contaminantes.

Ofrece una gran durabilidad, resistencia al peso, impermeabilidad y capacidad para soportar hasta 14 tintas de impresión; todo ello a un bajo coste, lo que hace del No Tejido una gran opción a la hora de combinar publicidad y respeto por el medio ambiente

*Non woven is a type of polypropilene that is enviromentaly friendly because no water is used in its production process, and it melts if it is permanently exposed to the sun. It is manufactured using contaminant free materials.*

*It provides durability, weight resistance, impermeability and hability to hold up to 14 printing inks, and all this together at a low cost, which makes non woven a very interesting option when combining publicity and environmental respect.*



PP 3842 L

Tote bag de TNT con dos asas largas

Non-woven tote bag with two long handles

38x42cm

70 gr/m<sup>2</sup>



max. print area  
28x28cm







**PP 3842 K**  
**Bolsa Clásica de TNT con dos asas cortas**  
 Non-woven tote bag with two short handles



38x42cm

70gr/m<sup>2</sup>



max. print area  
28x28cm



**PP 3842 B**  
**Bolsa de TNT con dos asas cortas y 5 cm. de base**  
 Non-woven tote bag with two short handles and bellows



38x42+5cm

80 gr/m<sup>2</sup>



max. print area  
28x28cm

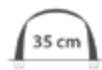



**PP 384210 L**

**Bolsa de TNT vertical con base y fuelle de 10 cm**  
Non-woven vertical bag with 10 cm bottom

38x42+10cm

70 gr/m<sup>2</sup>



max. print area  
28x28cm



**PP 383410L**

**Bolsa de TNT con base y fuelle de 10 cm**  
Non-woven horizontally tote bag with bottom and bellows

38x34+10cm

80 gr/m<sup>2</sup>



max. print area  
28x20cm



**PP 382910**

**Bolsa de TNT bicolor con base y fuelle de 10 cm**  
Non-woven horizontally two-coloured bag with bottom and bellows

38x29+10cm

70 gr/m<sup>2</sup>



max. print area  
28x8cm

28x3cm

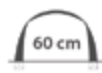



**PP 443810 L**  
**Bolsa de TNT con dos asas largas, troquel, base y fuelle de 10 cm**  
 Non-woven bag double handles

44x38+10cm    110 gr/m<sup>2</sup>    200    max. print area 30x20cm    56 cm

23    41    W    S



**PP 4836 B**  
**Bolsa de TNT con base de 10 cm, cremallera y bolsillo**  
 Non-woven bag with bottom, zip and inside pocket

48x36+10cm    130 gr/m<sup>2</sup>    200    max. print area 30x25cm    74 cm

Tamaño bolsillo interior: 14,5x15 cm aprox.  
 Pocket size: 14,5x15 cm approx.

23    W    S



**PP 453810 PL**  
**Bolsas de TNT plegables con base y fuelle de 10 cm**  
 Foldable bags with fold

45x38+10cm    70 gr/m<sup>2</sup>    200    max. print area 30x25cm    51 cm

20x10cm    8x8cm

W    06    23    67    47    41    96

S

*\*Esta bolsa en caso de ir impresa se entrega desplegada. Consultar suplemento para plegado.  
 This bag, if printed, is delivered unfolded. Please ask folding supplement.*





**PP 2010 PL Z**  
**Bolsas de TNT plegables con cremallera**  
 Foldable bags with zipper

38x42cm  
 20x10cm

70 gr/m<sup>2</sup>



max. print area  
 28x28cm  
 8x8cm



\*Esta bolsa en caso de ir impresa se entrega desplegada.  
 Consultar suplemento para plegado.  
 This bag, if printed, is delivered unfolded. Please ask folding supplement.



**PP 5050**  
**Bolsa cuadrada de TNT con dos asas cortas**  
 Non-woven squared-shaped bag with two short handles

50x50cm

70 gr/m<sup>2</sup>



max. print area  
 38x38cm



**PP 7050**  
**Bolsa grande de TNT con dos asas cortas**  
 Non-woven big bag with two short handles

70x50cm

70 gr/m<sup>2</sup>



max. print area  
 38x38cm





**PP 2226**

**Bolsa pequeña de TNT con dos asas cortas**

Non-woven small bag with two short handles

22x26cm      70 gr/m<sup>2</sup>      500      max. print area 14x16cm      20 cm

23      41      W      S



**PP 2212 ES**

**Estuche de TNT con cremallera**

Pencil case with zipper

22x12cm      80 gr/m<sup>2</sup>      1000      max. print area 8x13cm

23      43      S



**PP 2040**

**Bolsa de TNT porta botella**

Non-woven bag for bottle

20x40cm      80 gr/m<sup>2</sup>      500      max. print area 10x30cm      36 cm

41      W      S



**Mochila de TNT sin fondo**

**o con fondo redondo de 25 cm de diámetro**

Non-woven backpack without bottom or with rounded bottom of 25 cm

40x54 cm      70 gr/m<sup>2</sup>      250 u      max. print area 25x25 cm

**PP 4054 M**      40x54 cm      70      250 u      25x25 cm

**PP 4054 R**      40x54 cm      70      250 u      25x25 cm

W      41      S



### Sacos de TNT con cordón doble

Non-woven sack with cords



		gr/m <sup>2</sup>		max. print area
<b>PP 1014 Z</b>	10x14 cm	70	1000 u	6x9 cm
<b>PP 1520 Z</b>	15x20 cm	70	1000 u	8x13 cm
<b>PP 2530 Z</b>	25x30 cm	70	500 u	17x20 cm
<b>PP 3045 Z</b>	30x45 cm	70	250 u	22x30 cm
<b>PP 4050 Z</b>	40x50 cm	70	250 u	30x30 cm
<b>PP 5075 Z</b>	50x75 cm	70	200 u	38x38 cm



W 41 S



### PP 3842 ZK

### Bolsa de TNT con dos asas cortas y doble cordón

Non-woven small bag with two short handles



				max. print area
38x42cm	80 gr/m <sup>2</sup>	250	28x28cm	35 cm



W 41 S



### PP 3732 C

### Maletín de TNT "Campus"

Non-woven "Campus" briefcase



				max. print area
37x32+9cm	130 gr/m <sup>2</sup>	200	25x20cm	120 cm



91 47 23 S







## TNT LAMINADO Y RAFIA NON-WOVEN LAMINATED & RAFFIA



Nuestras bolsas de **Tejido No Tejido Laminado** y **Rafia** se fabrican a medida y totalmente personalizadas, son materiales que provienen **de importación**. Pídenos presupuesto para tu producto de TNT laminado o de Rafia. Al final del catálogo podrás encontrar las instrucciones para crear el packaging perfecto para tu cliente.

*Our **Laminated Non-Woven** and **Raffia** bags are made to measure and fully personalized, they are imported. Ask us for a quote for your laminated TNT or raffia product. At the end of the catalog you will find the instructions to create the perfect packaging for your client.*

### TEJIDO NO TEJIDO LAMINADO NON-WOVEN LAMINATED

Las bolsas de **Tejido No Tejido Laminado** son una variante dentro del no tejido que tienen un acabado diferente.

Se fabrica a través de un proceso que une el Tejido No Tejido a un film de PVC o Poliuretano, lo que le aporta esa resistencia y brillo que caracteriza a estas bolsas de tela. Como puedes ver la impresión se realiza en digital, consiguiendo acabados de gran calidad.

*Laminated non-woven bags are a variant within non-woven that have a different finish.*

*It is manufactured through a process that joins the Non-Woven Fabric to a PVC or Polyurethane film, which gives it that resistance and shine that characterizes these fabric bags. As you can see, printing is done digitally, achieving high-quality finishes.*





## BOLSAS DE RAFIA RAFFIA BAGS

El nombre de la **rafia** viene de una fibra natural que se encuentra en un árbol de palma africano, de ahí se ha extraído históricamente una fibra muy resistente y flexible que se ha usado en forma de hilo grueso en la industria del cordado, para tejer principalmente.

En la actualidad se utiliza más su **versión sintética** para la creación de bolsas de rafia, fibra obtenida por un proceso llamado extrusión del polietileno y el polipropileno. Lo que da como resultado un material con brillo, rígido pero a su vez ligero y muy resistente, perfecto para confeccionar bolsas de tela que soporten mucho peso y sean reutilizables, lo que convierte a este material en una opción más ecológica que las tradicionales bolsas de usar y tirar.

The name of raffia comes from a natural fiber found in an African palm tree, from which a very resistant and flexible fiber has historically been extracted, which has been used in the form of thick thread in the cordage industry, mainly for weaving.

Currently, its synthetic version is used more for the creation of raffia bags, a fiber obtained by a process called extrusion of polyethylene and polypropylene. This results in a material with a shine, rigid but at the same time light and very resistant, perfect for making cloth bags that support a lot of weight and are reusable, which makes this material a more ecological option than traditional disposable bags.







# MASCARILLAS HIGIÉNICAS HYGIENIC MASKS



Producimos mascarillas higiénicas reutilizables para adultos y niños fabricadas bajo la Especificación UNE 0065:2020 y CWA 17553:2020 (Normativa Europea), destinadas a la población civil y no a sanitarios. Nunca se van a considerar “Equipo de Protección Individual” (EPI) ni tampoco un Producto Sanitario (PS).

Trabajamos con tejido Certificado por AITEX (Asociación de Investigación de la Industria Textil que se dedica a la investigación, ensayos y certificación de artículos y materiales textiles) y por ITEL (Centro de Investigación y Asesoramiento para la limpieza).

*We produce reusable hygienic masks for adults and children manufactured under Specification UNE 0065: 2020 and CWA 17553: 2020 (European Regulation), intended for the civilian population and not for health workers. They will never be considered “Personal Protective Equipment” (PPE) or a Medical Device (PS).*

*We work with fabrics certified by AITEX (Textile Industry Research Association that is dedicated to research, testing and certification of textile articles and materials) and by ITEL (Research and Advice Center for cleaning).*



## MH5CR P

Mascarilla higiénica reutilizable de 5 capas con pliegues  
5 layers reusable face mask with pleats



Ensayos en laboratorio AITEX antes de lavar  
DATOS DEL ENSAYO: 2020TM0447 24/03/2020  
REFERENCIA: Mascarilla Confeccionada Prototipo  
EFICACIA FILTRACIÓN BACTERIANA: 99.20 ± 0,73  
RESPIRABILIDAD (Pa/cm<sup>2</sup>): 52 ± 3

Ensayos en laboratorio ITEL después de 16 lavados  
DATOS DEL ENSAYO ITEL 20/05/2020  
REFERENCIA CE-11916  
EFICACIA FILTRACIÓN BACTERIANA >92%  
RESPIRABILIDAD (Pa/cm<sup>2</sup>) <52



### MH5CR

Mascarilla higiénica reutilizable de 5 capas  
5 layers reusable face mask



TALLAS: XL, L, M, S.



aitex®  
textile research institute



Ensayos en laboratorio AITEX antes de lavar

DATOS DEL ENSAYO: 2020TM0447 24/03/2020

REFERENCIA: Mascarilla Confeccionada Prototipo

EFICACIA FILTRACIÓN BACTERIANA: 99.20 ± 0,73

RESPIRABILIDAD: (Pa/cm<sup>2</sup>): 52 ± 3

Ensayos en laboratorio ITEL después de 16 lavados

DATOS DEL ENSAYO ITEL 20/05/2020

REFERENCIA CE-11916

EFICACIA FILTRACIÓN BACTERIANA >92%

RESPIRABILIDAD (Pa/cm<sup>2</sup>) <52



### Mascarilla higiénica reutilizable de 1 capa Color Blanco o Negro

1 layer reusable face mask. White or black.



Blanca

MH1CR B

TALLAS: XL, L, M, S.



Negra

MH1CR N

TALLAS: XL, L, M, S.



aitex®  
textile research institute



Ensayos en laboratorio AITEX antes de lavar

DATOS DEL ENSAYO: 2020TM0680 14/04/2020

REFERENCIA: TEC 7191

EFICACIA FILTRACIÓN BACTERIANA: 95.57 ± 1,93

RESPIRABILIDAD: (Pa/cm<sup>2</sup>): 21 ± 2

Ensayos en laboratorio AITEX después de 10 lavados

DATOS DEL ENSAYO 2020TM02481 21/05/2020

REFERENCIA TEC 7191

EFICACIA FILTRACIÓN BACTERIANA 90.12 ± 2,10

RESPIRABILIDAD (Pa/cm<sup>2</sup>): 13 ± 1

Especificación UNE:0065

Ensayos en laboratorio AMS LAB después de 50 lavados

DATOS DEL ENSAYO 20-005246 26/06/2020

REFERENCIA CL 0838

EFICACIA FILTRACIÓN BACTERIANA 82.9 ± 0,7

RESPIRABILIDAD (Pa/cm<sup>2</sup>): 10 ± 1

Especificación Europea CWA 17553:2020



**MH1CPE**  
**Mascarilla higiénica reutilizable de 1 capa personalizable**

1-layer reusable hygienic mask customizable



*Personaliza tu mascarilla con varias opciones. Imprime la mascarilla completa o sólo con logotipo. Escoge también el tipo de acabado.*  
 Customize your mask however you want. Design the full mask or just your logo. Also choose the final details.



*Mascarilla completa*  
 XL, L, M, S.



*Logotipo de 6x6 cm*  
 XL, L, M, S.



*Diseño Carmen Almecija*



*Remallado*  
 XL, L, M, S.



*Doblado*  
 XL, L, M, S.



*Vivo*  
 XL, L, M, S.



*Pliegues. Combina con remallado o doblado.*  
 XL.

*Añade un clip a tus mascarillas*



Ensayos en laboratorio AITEX antes de lavar  
 DATOS DEL ENSAYO: 2020TMO680 14/04/2020  
 REFERENCIA: TEC 7191  
 EFICACIA FILTRACIÓN BACTERIANA: 95.57 ± 1,93  
 RESPIRABILIDAD: (Pa/cm<sup>2</sup>): 21 ± 2

Ensayos en laboratorio AITEX después de 10 lavados  
 DATOS DEL ENSAYO 2020TMO2481 21/05/2020  
 REFERENCIA TEC 7191  
 EFICACIA FILTRACIÓN BACTERIANA 90.12 ± 2,10  
 RESPIRABILIDAD (Pa/cm<sup>2</sup>): 13 ± 1  
 Especificación UNE-0065

Ensayos en laboratorio AMS LAB después de 50 lavados  
 DATOS DEL ENSAYO 20-005248 26/06/2020  
 REFERENCIA CL 0838  
 EFICACIA FILTRACIÓN BACTERIANA 82.7 ± 0,6  
 RESPIRABILIDAD (Pa/cm<sup>2</sup>): 12 ± 1  
 Especificación Europea CWA 17553:2020







# FABRICACIÓN A MEDIDA CUSTOM MANUFACTURING

HECHO EN ESPAÑA  
MADE IN SPAIN



## TÚ DISEÑA, NOSOTROS LO FABRICAMOS YOU DESIGN WE MANUFACTURE

Si tienes en mente un diseño diferente a todo lo mostrado en el catálogo, ¡no te preocupes, podemos darle forma! Para poner en marcha tu propio diseño exclusivo, necesitamos que tengas claros los siguientes pasos.

*If you have a different design in mind apart from everything we have in the catalogue, don't worry, we can work on it! To start up your own exclusive design, we need you to be clear about the following steps.*

## HECHO EN ESPAÑA O DE IMPORTACIÓN MADE IN SPAIN OR IMPORT

### 1. TIPO DE PRODUCTO

TYPE OF PRODUCT

Bolsas, sacos, mochilas, neceseres, fundas de jamón, guardatraje, monederos, reposacabezas, estuches, paños de cocina...

*Bags, sacks, rucksacks, vanity cases, ham covers, garment racks, purses, headrests, cases, kitchen towels...*

### 2. CANTIDAD

QUANTITY

Hecho en España a partir de 100 uds  
Importación a partir de 2.000 uds

*Made in Spain: minimum 100 pieces  
Import: minimum 2,000 pieces*

### 3. MEDIDAS

DIMENSIONS

Cuánto mide tu producto  $A \times B + C$   
(ancho x alto + fuelle en caso de llevarlo)

*What are the dimensions of your product  $A \times B + C$  (width x height + fold or gusset you want to add)*

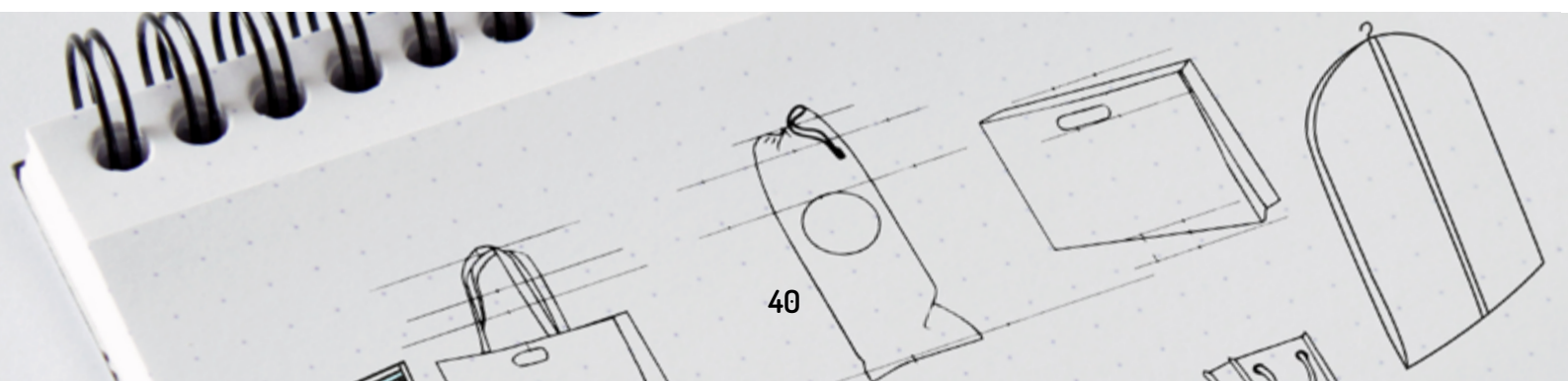
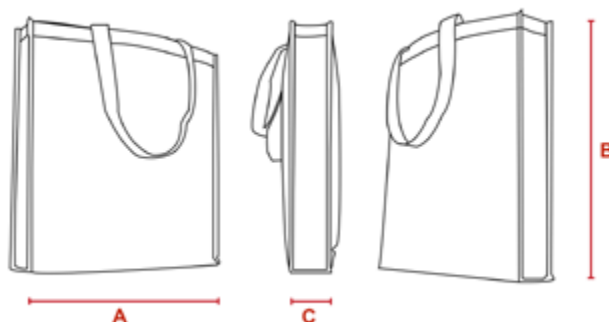



## 4. TEJIDO Y COLOR FABRIC AND COLOR



Algodón/Cotton

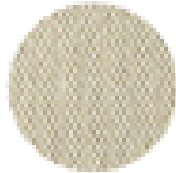

Loneta/Canvas

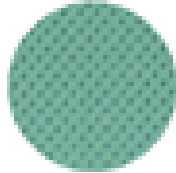

TNT/Non Woven



TNT Laminado\*  
Laminated  
Non Woven\*



Rafia/Raffia\*

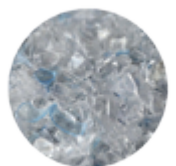

Poliéster, Nylon\*  
Polyester, Nylon\*

\* Materiales sólo para importación  
Materials only for import

## 5. ASAS O CIERRE HANDLES OR CLOSURE

Asas largas, cortas, anchas, bandolera, mezcla de asas cortas con asa bandolera, asas de cuero, de cinta de espiga, de poliéster, asas troqueladas, con cordón de algodón simple o doble.

*Long, short or wide handles, shoulder strap, mix of short handles with shoulder strap, leather handles, herringbone ribbon, polyester handles, die-cut handles, single or double drawstring.*



## 6. OTROS DETALLES ADD-ONS

Bolsillo interior, etiqueta exterior, etiqueta interior, embolsado individual, etiquetas colgantes...

*Inside pocket, inside or outside label, individually bagged packaging, tags label...*

## 7. IMPRESIÓN Y TÉCNICAS PRINTING & TECHNIQUES

Impresión a 1 cara, 2 caras, full printing o impresión total de la bolsa, en los fuelles o impresión interna.

Elige la técnica de impresión: Serigrafía o digital.

*Print on 1 side, 2 sides, full printing, gussets printing or inside printing*

*Choose the printing techniques: Screen printing or digital printing.*



Tintas planas



Tramado



Cuatricomía



Digital



Metalizados



Fluor



# FABRICACIÓN "HECHO EN ESPAÑA" MANUFACTURED "MADE IN SPAIN"

Apuesta por la economía circular y fabrica tus **productos personalizados** en España.

*Bet on circular economy and manufacture your own and exclusives products in Spain.*

- Desde 100 unidades.
  - Plazos de entrega aproximados de 3 a 5 semanas según producción.
  - Fabricación 100% nacional.
  - Tejidos: algodón natural, algodón orgánico, algodón loneta y tejido no tejido.
  - Consultar otros materiales.
- 
- *Minimum 100 units.*
  - *Approximate delivery times from 3 to 5 weeks.*
  - *100% Made in Spain.*
  - *Fabrics: standard cotton, organic cotton, canvas cotton, non-woven.*
  - *Ask for different fabrics.*





## FABRICACIÓN DE IMPORTACIÓN MANUFACTURE WITH IMPORT

Gracias a la importación podemos ampliar nuestra oferta de materiales que se usan para la fabricación de bolsas reutilizables como son por ejemplo la **Rafia** o el **Tejido No tejido laminado** impresos a todo color.

*If we import, we can offer others materials we use to manufacture reusable bags, as **raffia** or **laminated non-woven** printed in full colour.*

- Desde 2.000 unidades
- Plazos de entrega aproxi. de 6 a 14 semanas, según vía aérea o marítima.
- Amplia variedad de materiales: rafia, no tejido laminado brillo o mate, algodón de diferentes gramajes, material isotérmico...

- *Minimum 2,000 units*
- *Approximate delivery times from 6 to 14 weeks, import by air or by sea.*
- *Wide variety of materials: raffia, glossy or matt laminated non-woven, cotton of different weights, isothermal material...*

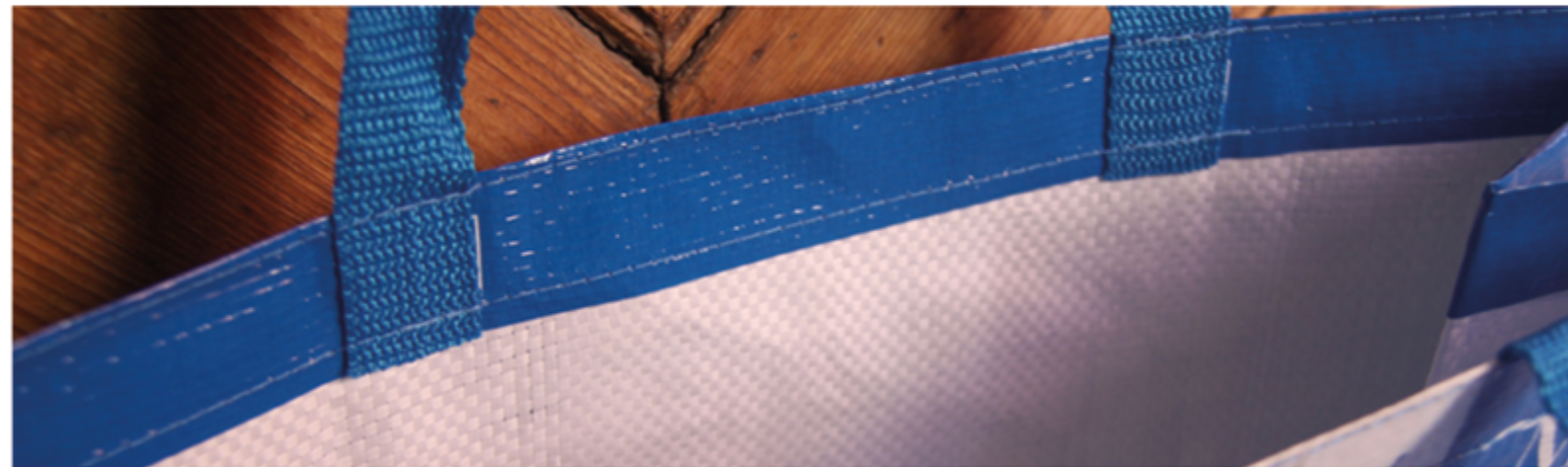





## INFORMACIÓN DE PRODUCTO

- Lote de entintado: cada partida de tela de algodón puede variar ligeramente de partidas anteriores.
- Tamaño: el tamaño de las bolsas es aproximado y puede variar en un pequeño porcentaje en alguna de sus medidas.
- Instrucciones de lavado: se ruega lean detenidamente y sigan las instrucciones antes de proceder al mismo.
- Las impresiones sobre colores oscuros incluyen una base blanca previa al color solicitado, para garantizar así la calidad de la serigrafía.
- Colores especiales: para la fabricación con colores especiales no incluidos en catálogo, consultar mínimos.

## PRODUCT INFORMATION

- *Dye lot: each cotton fabric dye lot may slightly vary from previous lots.*
- *Sizes: all sizes are approximated and finished goods may vary some percent up or down.*
- *Washing instructions: please read carefully and follow washing instructions before proceeding with it.*
- *Printing on dark colors include a white base prior to the requested color, to guarantee the quality of screen printing.*
- *Special colours: to manufacture special pantones not included in catalogue.*

## INSTRUCCIONES DE LAVADO CARE INSTRUCTIONS

### Para bolsas bordadas

- Siga las instrucciones de lavado
- No rayar el bordado con objetos afilados

### Para bolsas impresas hechas de bambú o material PP

- No lavar, cepillar, rayar, lavar en seco o planchar

### Para bolsas impresas hechas de algodón y telas similares

- No use las bolsas hasta 24 horas después de que el proceso de impresión haya terminado
- No blanquear, centrifugar, cepillar, torcer o rayar
- Lavar y planchar del revés
- No lavar en seco
- No utilice suavizante y utilice únicamente detergentes suaves
- Programas de lavado: delicado o lavar a mano hasta 30°C



### For embroidered bags

- Refer to the bags washing instructions
- Do not scratch with sharp object across the embroidery

### For printed bags made from bamboo or PP-material

- Do not wash, brush, scratch, dry clean or iron

### For printed bags made from cotton and similar fabrics

- Do not use the bags until 24 hours after printing process has finished (flock coated bags not until 10 days after flocking)
- Do not bleach, spin, brush, wring, scratch or iron
- Wash printed bags inside out
- Do not dry clean
- Do not use fabric softener and only use mild detergents
- Wash programs: delicate or hand wash up to 30°C only





Soliciten precios a: [pptos@detaliagrupo.com](mailto:pptos@detaliagrupo.com)